



BIDIREZIONALE  
BI-ROTATIONAL

# PE

Pompa a Pistoni  
Piston Pump

CODICE DI ORDINAZIONE / ORDERING CODE

201 PE 040 Z SE

TIPO / TYPE  
CILINDRATA / DISPLACEMENT  
VERSIONE / VERSION  
DIN 5462

DIN  
5 4 6 2  
SE

PE 40  
PE 50  
PE 60

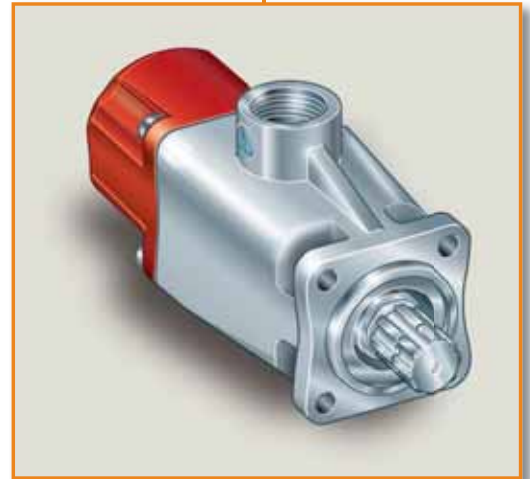

POMPA A PISTONI / PISTON PUMP

CARATTERISTICHE E DATI TECNICI / SPECIFICATIONS AND TECHNICAL DATA

TIPO TYPE	CODICE CODE	A mm	B mm	C mm	D mm	E ASPIRAZIONE INLET	F MANDATA OUTLET	PESO WEIGHT kg
PE 40	201PE040ZSE	232.5	945	85	106	1" 1/4 G	1" G	10.6
PE 50	201PE050ZSE							10.6
PE 60	201PE060ZSE							10.6

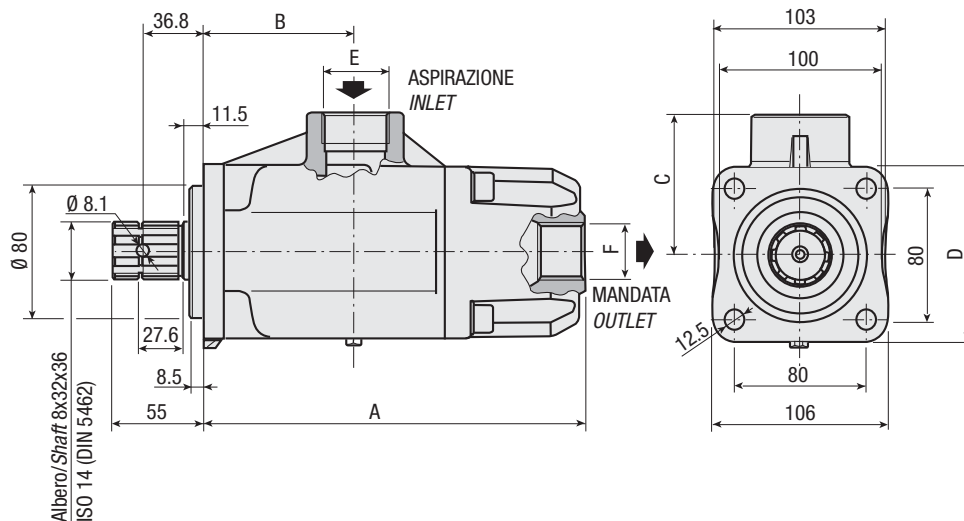

DATI TECNICI / TECHNICAL DATA

ESEMPIO CICLI LAVORO / EXAMPLE OF WORKING CYCLES

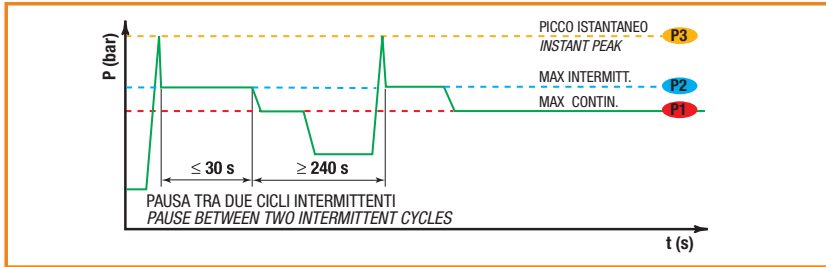

Pressione d'aspirazione: Inlet pressure:	0.7 ÷ 1.5 bar (assoluti/absolute)
Campo viscosità lavoro: Operating viscosity range:	12 ÷ 100 cSt
Temperatura fluido °C (t): Fluid temperature °C (t):	-10° + 80° C

Pressione Lavoro Working Press. P2	Contaminazione / Contamination		Filtro / Filter βx = 75
	NAS 1638	ISO 4406	
≤ 200 bar	12	21/18	40 μm
≥ 200 bar	11	20/17	25 μm

◀ FILTRAZIONE CONSIGLIATA (ritorno o mandata)  
RECOMMENDED FILTERING (return or outlet)

TIPO / TYPE			PE40	PE50	PE60
Cilindrata Displacement	Vg	cm <sup>3</sup> /n cm <sup>3</sup> /rev.	37	50	60
Pressione massima continua Max continuous operating pressure	P1	bar	330	330	290
Pressione massima intermittente Max intermitt. operat. press. (max 30 s)	P2		360	360	340
Pressione massima di picco Max peak pressure (≤ 0.1 s)	P3		500	500	400
Velocità massima intermittente Max intermittent speed (P ≤ 20 bar)	n3	n/min r.p.m.	2400	2400	2100
Velocità massima continua Max continuous speed (≤ P1)	n1		1800	1800	1700
Velocità minima intermittente Min intermittent speed (≤ P2 x 0.5) (max 30 s)	n4		400	400	300

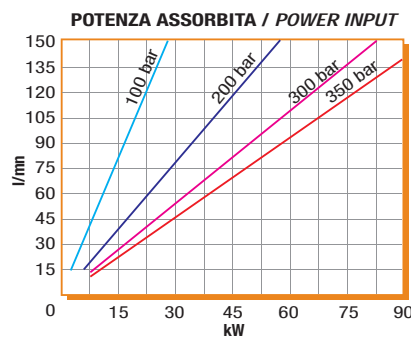
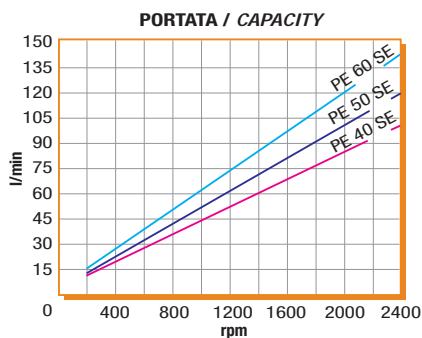

DIAGRAMMI / DIAGRAMS

RENDIMENTO VOLUMETRICO / VOLUMETRIC EFFICIENCY

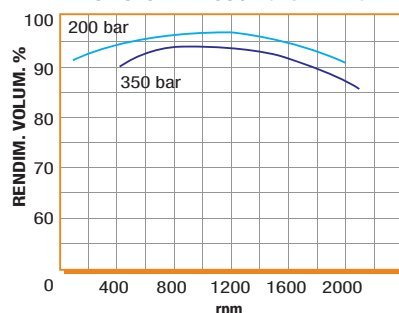

COPPIA ASSORBITA / DRIVE TORQUE

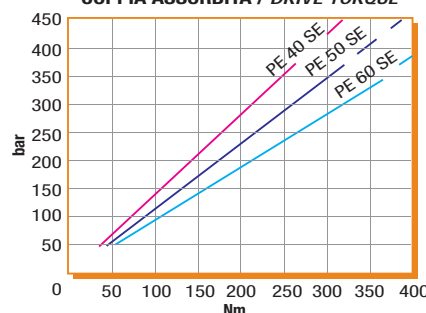

RILIEVI ESEGUITI CON OLIO  
ISO VG 46 A 50° C (ν<sub>40</sub> = 30 cSt)  
THE ABOVE SPECIFICATIONS  
REFER TO OIL TYPE ISO  
VG 46 AT 50° C (ν<sub>40</sub> = 30 cSt)

